

## GS1M

### 1.0AMP. GLASS PASSIVATED SURFACE MOUNT RECTIFIERS

#### FEATURE

- . High current capability
- . Low forward voltage drop
- . Low power loss, high efficiency
- . High temperature soldering guaranteed:  
260°C/10 seconds at terminals.
- . For surface mounted application
- . Easy pick and place

#### MECHANICAL DATA

- . Case: Molded plastic
- . Epoxy: UL94V-0 rate flame retardant
- . Lead: MIL-STD- 202E, Method 208 guaranteed
- . Polarity:Color band denotes cathode end
- . Packaging:12mm tape per EIA STD RS-481
- . Mounting position: Any

#### SMA (DO-214AC)

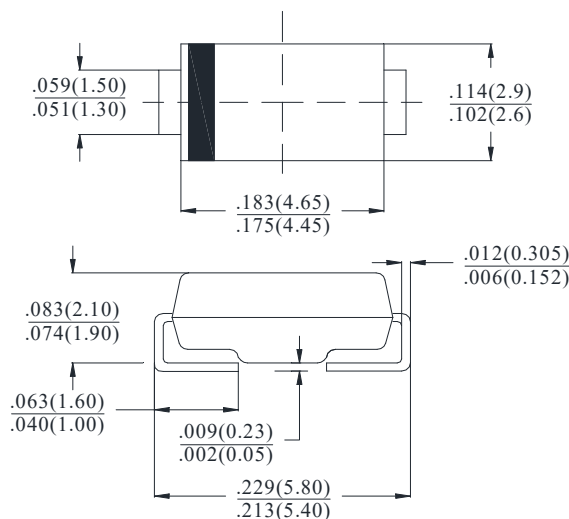

#### MAXIMUM RATINGS AND ELECTRICAL CHARACTERISTICS

Ratings at 25°C ambient temperature unless otherwise specified.

Single phase, half wave, 60Hz, resistive or inductive load. For capacitive load, derate current by 20%

Type Number	SYM BOL	GS1M	units
Maximum Recurrent Peak Reverse Voltage	$V_{RRM}$	1000	V
Maximum RMS Voltage	$V_{RMS}$	700	V
Maximum DC blocking Voltage	$V_{DC}$	1000	V
Maximum Average Forward Rectified Current	$I_{F(AV)}$	1.0	A
Peak Forward Surge Current 8.3ms single half sine-wave superimposed on rated load (JEDEC method)	$I_{FSM}$	30.0	A
Maximum Forward Voltage at 1.0A DC	$V_F$	1.1	V
Maximum DC Reverse Current @ $T_J=25^\circ\text{C}$ at rated DC blocking voltage @ $T_J=125^\circ\text{C}$	$I_R$	5.0	$\mu\text{A}$
		100.0	
Typical Junction Capacitance (Note1)	$C_j$	8	pF
Typical Thermal Resistance (Note 2)	$R_{(JA)}$	75	$^\circ\text{C}/\text{W}$
	$R_{(JC)}$	25	
	$R_{(JL)}$	22	
Storage Temperature	$T_{STG}$	-55 to +150	$^\circ\text{C}$
Operation Junction Temperature	$T_J$	-55 to +150	$^\circ\text{C}$

#### Note:

1. Measured at 1.0 MHz and applied reverse voltage of 4.0Vdc
2. Measured on P.C.Board with 0.2×0.2”(5.0×5.0mm)Copper Pad Areas.

**RATING AND CHARACTERISTIC CURVES**

FIG.1-TYPICAL FORWARD CURRENT DERATING CURVE

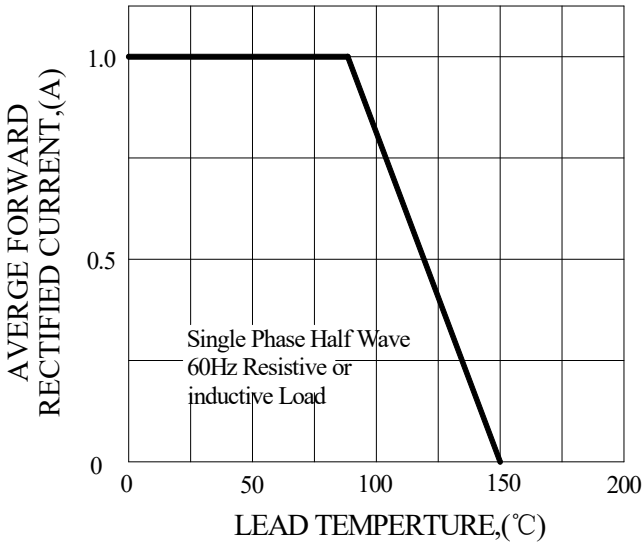

FIG.2-TYPICAL INSTANTANEOUS FORWARD CHARACTERISTICS

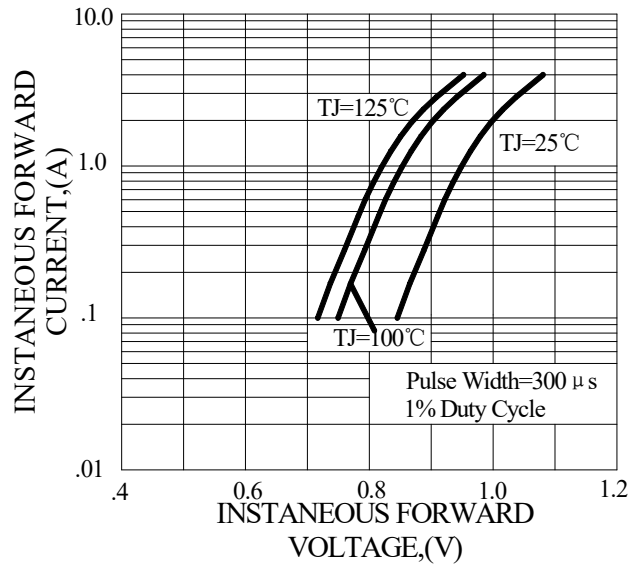

FIG.3-MAXIMUN NON-REPETITIVE FORWARD SURGE CURRENT

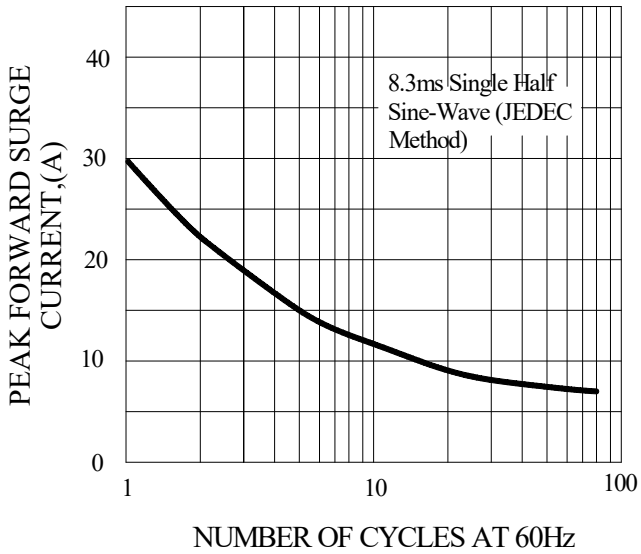
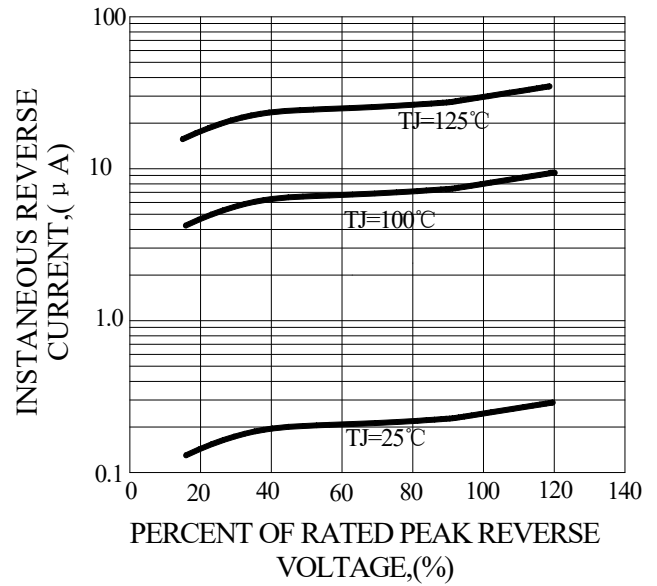
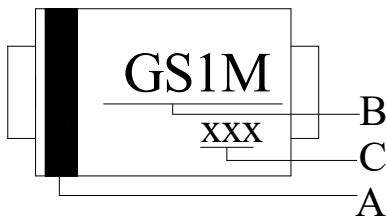

FIG.4-TYPICAL REVERSE CHARACTERISTICS



## Marking and packaging illustration

### 1、Marking



SYMBOL	Explanation
A	Color Band Denotes Cathode
B	Product Name
C	Date Code

### 2、Packaging

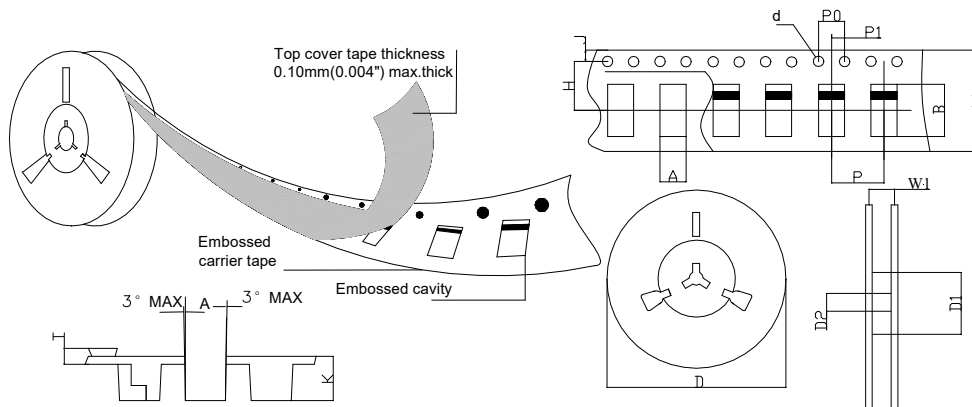

SPECIFICATIONS mm(inch)		PACKAGE	SPECIFICATIONS mm(inch)		PACKAGE
ITEM	SYM BOL	SMA (DO-214AC)	ITEM	SYM BOL	SMA (DO-214AC)
Carrier width	A	3.17(0.125)Max	Carrier depth	K	2.42(0.095)Typ
Carrier length	B	5.81(0.229)Max	Punch hole pitch	P	4.00(0.157)Typ
Sprocket hole	d	ø1.55(0.061)Typ	Sprocket hole pitch	P0	4.00(0.157)Typ
Reel outer diameter	D	330.0(13)Typ	Embossment center	P1	2.00(0.079)Typ
Reel inner diameter	D1	50.0(1.969)Min	Overall tape thickness	T	0.30(0.012)Typ
Feed hole diameter	D2	13.0(0.512)Typ	Tape width	W	12.0(0.472)Typ
Sprocket hole position	J	1.75(0.069)Typ	Reel width	W1	12.4(0.488)Min
Punch hole position	H	5.55(0.219)Typ			